

KW4A型微動開關系列 Micro switch series

◆ 安全可靠的小型開關 Safe, reliable miniature switch

- 結構緊湊。具有微小觸點間隙，快速動作、高靈敏和微小動作行程的特點。
Nice appearance, tight configuration. Characteristic: small contact gap, quick action, high sensitivity and small operating travel.
- 長壽命，高可靠。
Long life, high reliability.
- 接線端子種類齊全
A variety of contact terminals
- 配備各種形式動臂
A variety of levers.
- 採用熱固性或熱塑性塑料外殼
Adopt thermosetting plastic or thermoplastic case.
- 廣泛應用於各種家用電器、電子設備、自動化設備、通訊設備、汽車電子、儀器儀表等領域。
Widely used in home appliance, electronic equipment, automatic machine, communication equipment, car electron, apparatus and instrument etc.

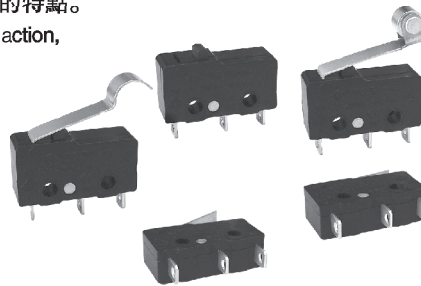

◆ 技術特性 Technical Characteristics

項目 Item		特性值 Value
工作速度 Operating speed		0.1mm ~ 1m/s (與驅動方式有關) (Related with actuator forms)
工作頻率 Operating frequency		機械 60次/min; 電氣 25次/min Mechanical 60 cycles/min; Electrical 25 cycles/min
絕緣電阻 Insulation resistance		≥ 100MΩ (500VDC)
接觸電阻 Contact resistance		動作力 > 0.5N: ≤ 30mΩ (見注) 動作力 ≤ 0.5N: ≤ 50mΩ (見注) OF > 0.5N: ≤ 30mΩ (see note) OF ≤ 0.5N: ≤ 50mΩ (see note)
耐電壓 Test voltage	同極不相接端子間 Between terminals of the same polarity	AC1000V, 50/60Hz, 1min
	帶電金屬零件與地(外殼)之間、接線端與不帶電金屬件之間 Between current-carrying metal parts and ground(case), and between each terminal and non-current-carrying metal parts.	AC1500V, 50/60Hz, 1min
抗振動 Vibration resistance		10 ~ 55Hz, 1.5mm 雙振幅 Double amplitude
抗衝擊 Shock resistance		破壞: 動作力 > 0.5N: 1000m/s ² (約100G)max 動作力 ≤ 0.5N: 500m/s ² (約50G)max 故障: 動作力 > 0.5N: 300m/s ² (約30G)max 動作力 ≤ 0.5N: 200m/s ² (約20G)max Destruction: OF > 0.5N: 1000m/s ² (approx. 100G)max OF ≤ 0.5N: 500m/s ² (approx. 50G)max Malfunction: OF > 0.5N: 300m/s ² (approx. 30G)max OF ≤ 0.5N: 200m/s ² (approx. 20G)max
壽命 Life		機械 ≥ 1,000,000次; Mechanical ≥ 1,000,000 cycles 電氣 ≥ 10,000次; Electrical ≥ 10,000 cycles
質量 Weight		約1.6g(無動臂型) Approx. 1.6g(No lever)
安全認證 Safety approvals		UL、CUL、VDE、TUV、ENEC、DEMKO、CE、EK、CQC

注：指無動臂時按紐上的動作力。 Note: Refers to the operating force of no lever.

微動開關系列 MICRO SWITCH SERIES

KW3A

KW4A

KW4A(S)

KW10

MS1

MS2

MS3

MS5

MS10

防水開關系列 WATERPROOF SWITCH SERIES

WS1

WS1L

WS2

WS3

WS4

WS5

WS6

WS7

電源開關系列 POWER SWITCH SERIES

KDC-A11

KDC-A04

PS4

PS5

PS6

RS1

RS2

RS3

其他開關系列 OTHER SWITCH SERIES

SP02

KXZ2

PRS1

◆ 型號規格命名及含義 Model number legend and meanings

KW4A □-□□□□□□□ - (□)
 1 2 3 4 5 6 7 8 9

1 溫度等級 Degree of temperature	無標記 No mark: 10T85 10T105 25T125	6 端子類型 Terminal type	F: 焊接端子 Solder terminal P: PCB端子 PCB terminal L: 左側面PCB端子 Left side PCB terminal R: 右側面PCB端子 Right side PCB terminal T: 110快接端子 Quick-connect terminal Y: 非標準端子 Not standard terminal
	2 額定值 Ratings		無標記 No mark: 5A125/250VAC 5(2)A250VAC 5(3)A125/250VAC 5GPA125/250VAC 1/4hp250VAC,4A30VDC KW4A-A: 10(4)A125/250VAC 10(3)A250VAC 10GPA125/250VAC 1/2hp250VAC 4A30VDC
3 接觸形式 Circuit	Z: 轉換式 SPDT T: 常開(按通)式 SPST-NO D: 常閉(按斷)式 SPST-NC (見說明圖 See illustration)	8 按鈕規格 Plunger spec	無標記: 標準按鈕 No mark: standard plunger A: 短按鈕 Short plunger B: 長按鈕 Long plunger D: 异形按鈕 Abnormity plunger (見說明圖 see illustration) 注: 若採用本表中未列入的非標準按鈕, 則用此新增按鈕的規格代號(本公司確認)表示。 Note: if adopt other not standard plunger, then indicate with the new spec (confirmed by our company).
	4 驅動形式 Actuator forms		0: 無動臂 No lever 1: 短動臂 Short lever 2: 長動臂 Long lever 3: 中動臂 Middle lever 5: 滾輪臂 Roller 6: 弧形動臂 Arc lever <input type="checkbox"/> : 非標準動臂 Not standard lever 注: <input type="checkbox"/> 表示非標準動臂的代號, 詳見動臂外形尺寸圖。 Note: <input type="checkbox"/> Indicate not standard lever, details see outline measurement drawings.
5 外殼材質 Case material	G: 熱固性 Thermosetting S: 熱塑性 Thermoplastic		

◆ 接觸形式說明圖 Circuit illustration

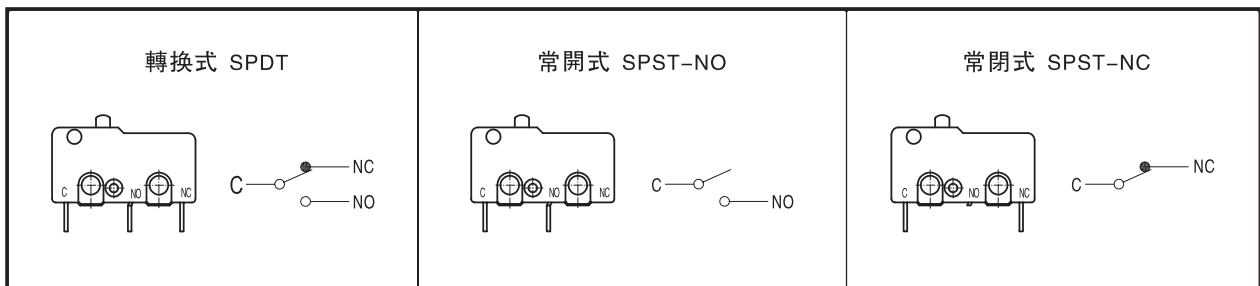

◆ 按鈕規格說明圖 Plunger spec illustration

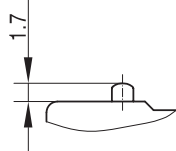
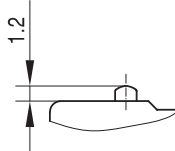
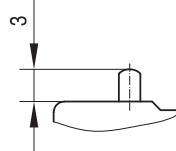
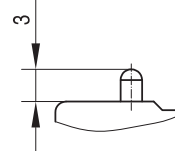
按鈕標記 Mark on plunger	無標記 No mark	A	B	D
按鈕尺寸 Plunger dimensions				

◆ 接線端尺寸 Terminal dimensions

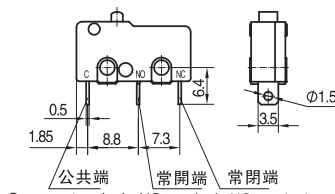
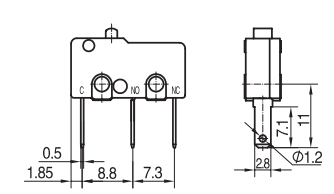
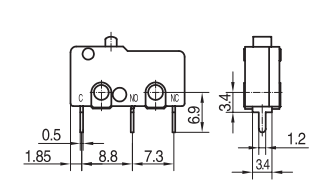
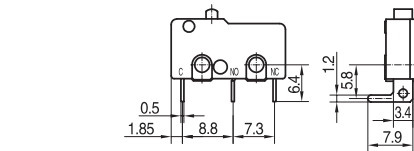
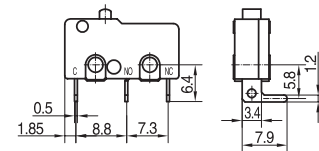
<p>F 焊接端子 Solder terminal</p> 	<p>T 快接端子#110 Quick connect terminal #110</p> 	<p>P PCB端子 PCB terminal</p> 
<p>L 左側面PCB端子 Left side PCB terminal</p> 	<p>R 右側面PCB端子 Right side PCB terminal</p> 	

◆ 安裝孔尺寸 Mounting hole dimensions

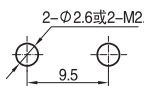
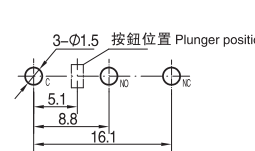
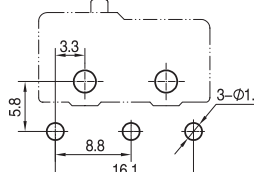
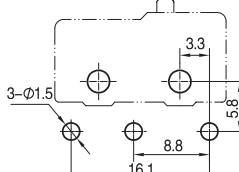
	<p>PCB端子 PCB terminal</p> 	<p>左側面PCB端子 Left side PCB terminal</p> 	<p>右側面PCB端子 Right side PCB terminal</p> 
---	---	--	---

◆ 內部構造圖 Internal configuration drawing

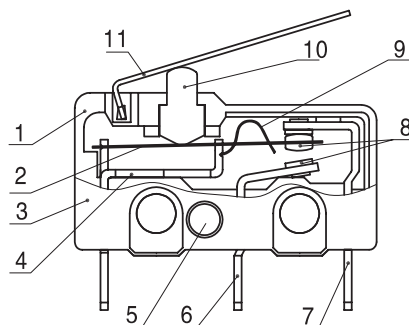
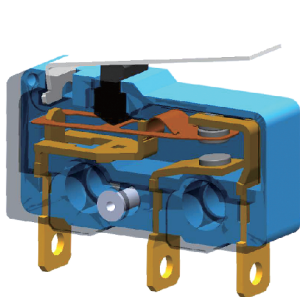

- | | |
|-----------|--------------|
| 1 基座 | Case |
| 2 可動片 | Moving piece |
| 3 蓋 | Cover |
| 4 支架 | Support |
| 5 鉚釘 | Rivet |
| 6 常開端子 | NO terminal |
| 7 常閉端子 | NC terminal |
| 8 電觸點 | Contact |
| 9 簧片 | Spring |
| 10 按鈕 | Plunger |
| 11 動臂(杠杆) | Lever |

微動開關系列
MICRO SWITCH SERIES

KW3A

KW4A

KW4A(S)

KW10

MS1

MS2

MS3

MS5

MS10

防水開關系列
WATERPROOF SWITCH SERIES

WS1

WS1L

WS2

WS3

WS4

WS5

WS6

WS7

電源開關系列
POWER SWITCH SERIES

KDC-A11

KDC-A04

PS4

PS5

PS6

RS1

RS2

RS3

其他開關系列
OTHER SWITCH SERIES

SP02

KXZ2

PRS1

◆ 外形尺寸和動作特性 Dimensions and operating characteristics
微動開關系列
MICRO SWITCH SERIES

- KW3A
- KW4A**
- KW4A(S)
- KW10
- MS1
- MS2
- MS3
- MS5
- MS10

KW4A-Z0□F100
 KW4A-Z0□F150
 KW4A-Z0□F200
 KW4A-Z0□F300

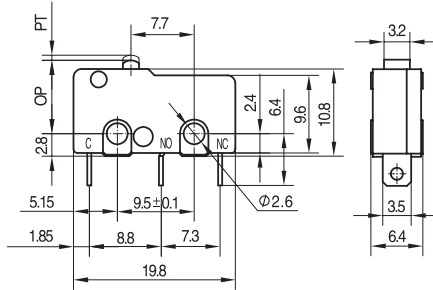
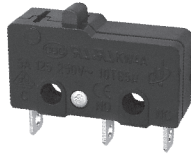

型號 Model	KW4A-Z0□F100	KW4A-Z0□F150	KW4A-Z0□F200	KW4A-Z0□F300
OF Max(N)	1.00	1.50	2.00	3.00
RF Min(N)	0.20	0.35	0.50	0.80
PT Max(mm)	0.8			
OT Min(mm)	0.5			
MD Max(mm)	0.2			
OP(mm)	9.1 ± 0.4			

防水開關系列
WATERPROOF SWITCH SERIES

- WS1
- WS1L
- WS2
- WS3
- WS4
- WS5
- WS6
- WS7

KW4A-Z1□F100
 KW4A-Z1□F150
 KW4A-Z1□F200
 KW4A-Z1□F300

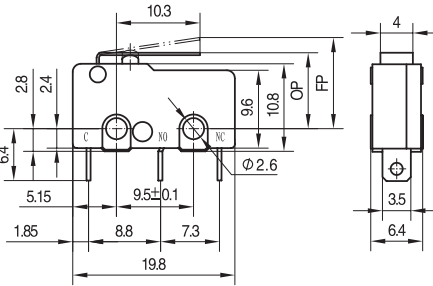
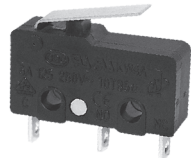

型號 Model	KW4A-Z1□F100	KW4A-Z1□F150	KW4A-Z1□F200	KW4A-Z1□F300
OF Max(N)	0.35	0.60	0.80	1.00
RF Min(N)	0.05	0.15	0.20	0.35
OT Min(mm)	1.5			
MD Max(mm)	0.6			
FP Max(mm)	12.0			
OP(mm)	9.5 ± 0.8			

電源開關系列
POWER SWITCH SERIES

- KDC-A11
- KDC-A04
- PS4
- PS5
- PS6

KW4A-Z3□F100
 KW4A-Z3□F150
 KW4A-Z3□F200
 KW4A-Z3□F300

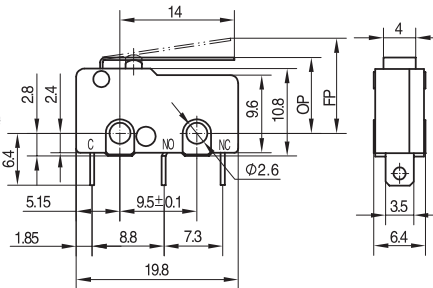

型號 Model	KW4A-Z3□F100	KW4A-Z3□F150	KW4A-Z3□F200	KW4A-Z3□F300
OF Max(N)	0.30	0.45	0.60	0.85
RF Min(N)	0.05	0.10	0.15	0.20
OT Min(mm)	1.0			
MD Max(mm)	0.8			
FP Max(mm)	13.0			
OP(mm)	9.8 ± 1			

- RS1
- RS2
- RS3

KW4A-Z2□F100
 KW4A-Z2□F150
 KW4A-Z2□F200
 KW4A-Z2□F300

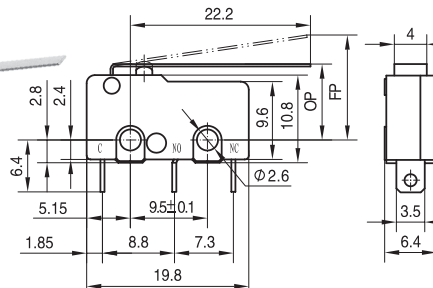

型號 Model	KW4A-Z2□F100	KW4A-Z2□F150	KW4A-Z2□F200	KW4A-Z2□F300
OF Max(N)	0.20	0.30	0.40	0.60
RF Min(N)	0.03	0.08	0.10	0.18
OT Min(mm)	2.0			
MD Max(mm)	1.5			
FP Max(mm)	16.0			
OP(mm)	10 ± 1.5			

其他開關系列
OTHER SWITCH SERIES

- SP02
- KXZ2
- PRS1

Since 1995, we focus on switches

◆ 外形尺寸和動作特性 Dimensions and operating characteristics

KW4A-Z6□F100
KW4A-Z6□F150
KW4A-Z6□F200
KW4A-Z6□F300

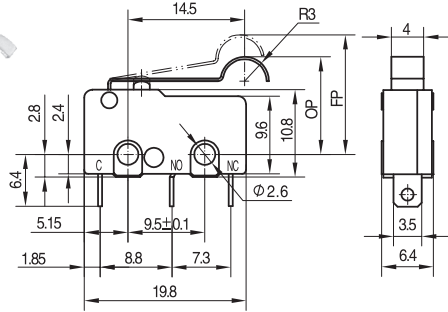
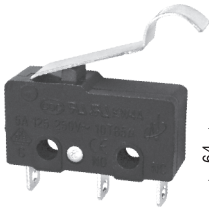

型號 Model	KW4A-Z6□F100	KW4A-Z6□F150	KW4A-Z6□F200	KW4A-Z6□F300
OF Max(N)	0.30	0.45	0.60	0.85
RF Min(N)	0.05	0.10	0.15	0.20
OT Min(mm)	1.2			
MD Max(mm)	0.8			
FP Max(mm)	17.5			
OP(mm)	14.5 ± 1			

KW4A-Z5□F100
KW4A-Z5□F150
KW4A-Z5□F200
KW4A-Z5□F300

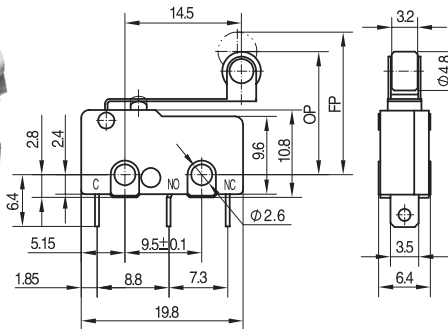

型號 Model	KW4A-Z5□F100	KW4A-Z5□F150	KW4A-Z5□F200	KW4A-Z5□F300
OF Max(N)	0.30	0.45	0.60	0.85
RF Min(N)	0.05	0.10	0.15	0.20
OT Min(mm)	1.2			
MD Max(mm)	0.8			
FP Max(mm)	19.0			
OP(mm)	16.2 ± 1			

KW4A-ZE□F100
KW4A-ZE□F150
KW4A-ZE□F200
KW4A-ZE□F300

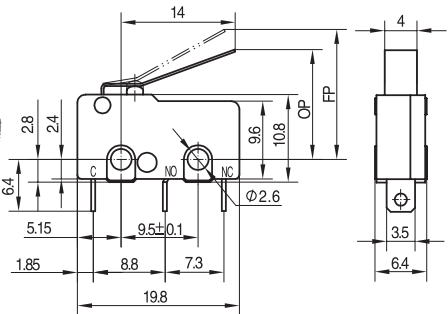
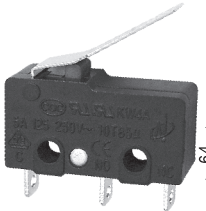

型號 Model	KW4A-ZE□F100	KW4A-ZE□F150	KW4A-ZE□F200	KW4A-ZE□F300
OF Max(N)	0.30	0.45	0.60	0.85
RF Min(N)	0.05	0.10	0.15	0.20
OT Min(mm)	1.2			
MD Max(mm)	0.8			
FP Max(mm)	17.5			
OP(mm)	14 ± 1			

KW4A-ZQ□F100
KW4A-ZQ□F150
KW4A-ZQ□F200
KW4A-ZQ□F300

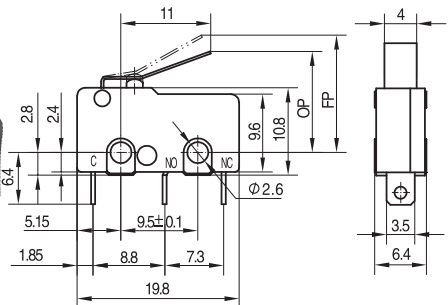

型號 Model	KW4A-ZQ□F100	KW4A-ZQ□F150	KW4A-ZQ□F200	KW4A-ZQ□F300
OF Max(N)	0.32	0.50	0.65	1.00
RF Min(N)	0.05	0.10	0.15	0.20
OT Min(mm)	1.2			
MD Max(mm)	0.8			
FP Max(mm)	15.5			
OP(mm)	13.2 ± 1			

微動開關系列
MICRO SWITCH SERIES

KW3A

KW4A

KW4A(S)

KW10

MS1

MS2

MS3

MS5

MS10

防水開關系列
WATERPROOF SWITCH SERIES

WS1

WS1L

WS2

WS3

WS4

WS5

WS6

WS7

電源開關系列
POWER SWITCH SERIES

KDC-A11

KDC-A04

PS4

PS5

PS6

RS1

RS2

RS3

其他開關系列
OTHER SWITCH SERIES

SP02

KXZ2

PRS1

◆ 外形尺寸和動作特性 Dimensions and operating characteristics

KW4A-Z6B□F100
 KW4A-Z6B□F150
 KW4A-Z6B□F200
 KW4A-Z6B□F300

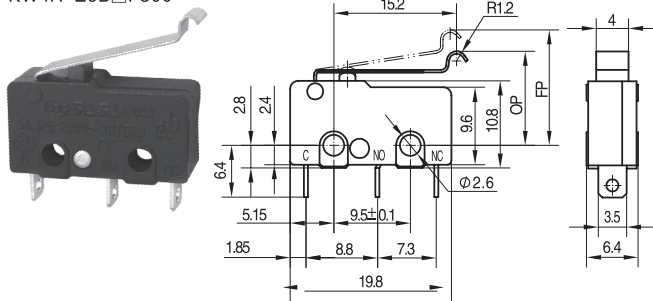

型號 Model	KW4A-Z6B□F100	KW4A-Z6B□F150	KW4A-Z6B□F200	KW4A-Z6B□F300
OF Max(N)	0.25	0.40	0.50	0.75
RF Min(N)	0.05	0.10	0.15	0.20
OT Min(mm)	1.2			
MD Max(mm)	0.8			
FP Max(mm)	16.5			
OP(mm)	13 ± 1.2			

◆ 可供選擇的非標準動臂代號和外形特徵尺寸 Not standard levers for choose and outline characteristic dimensions

動臂代號 Lever code	外形特徵尺寸 Outline characteristic dimensions	動臂代號 Lever code	外形特徵尺寸 Outline characteristic dimensions	動臂代號 Lever code	外形特徵尺寸 Outline characteristic dimensions
3A		C		K	
N		G		Q1	
J		F1		S1	
J1		6A		5A	
J2		6C			

防水開關系列
WATERPROOF SWITCH SERIES

- WS1
- WS1L
- WS2
- WS3
- WS4
- WS5
- WS6
- WS7

電源開關系列
POWER SWITCH SERIES

- KDC-A11
- KDC-A04
- PS4
- PS5
- PS6

- RS1
- RS2
- RS3

其他開關系列
OTHER SWITCH SERIES

- SP02
- KXZ2
- PRS1

◆ 請正確使用 Please use it correctly

【共通注意事項】請參閱相關頁 P3-10。

【Common points for attention】please refer to related pages P3-10

■ 關於和端子的連接 Concerning the connection with terminals

(1) 將導線焊接到端子上時，請先將導線穿過端子孔後再進行焊接。

When jointing the wire to the terminal, please thread through the wire to the hole of the terminal first.

(2) 烙鐵的容量應為60W以下，焊接時間在3s之內。若操作溫度過高或時間過長，可能導致開關特性劣化。

The iron capacity should be below 60W, joint time within 3s. If operate temperature is too high or time is too long, switch characteristic may be worsen

(3) 請採用手工焊接。因為如果採用焊槽焊接，焊錫可能進入開關內部而導致接觸不良。

Please joint with hands. If joint with wave soldering, soldering tin may come inside the switch, then bad contact will happen.

(4) 對於快接式端子，插套插入插片時，應避免在端子的橫向加力，以免引起端子變形和外殼破損。

Regarding the quick connect terminal, when insert slipcover into the insert piece, please do not exert transverse press to the terminal, in order to avoid terminal distort and cover breakage.

■ 關於絕緣距離 Concerning insulation distance

根據IEC 61058-1/EN 61058-1/GB 15092.1之規定，本開關的最小絕緣層厚度為1.1mm，端子和安裝板之間的最小空間距離為1.6mm。如果無法確保零件所要求的絕緣距離，請使用絕緣護罩或隔板來保證絕緣距離。

According to IEC 61058-1/EN 61058-1/GB 15092.1, the least thickness insulation layer should be 1.1mm, the smallest space distance between the terminal and install board is 1.6mm. If the parts insulation distance cannot be guaranteed please use insulate cover or the guard board to guarantee the insulation distance.

■ 關於安裝 Concerning installation

(1) 開關的安裝、拆卸和配線作業以及維護檢查時，請務必斷開電源，否則會引起觸電和燒毀。

Please turn off the power when installing, disassembling, wiring work and maintenance check, otherwise, electric shock and burn will happen.

(2) 安裝時，使用2個M2.3螺釘，用平墊圈、彈簧墊圈等緊固，並請使用0.23~0.26N·m的緊固轉矩。

When installing, please use 2 M2.3 screws, then tight it with flat washer, spring washer, and also tight with 0.23~0.26N·m torque.

(3) 開關請安裝在平面上。如果安裝面凹凸不平，可能導致開關歪斜、動作失常和外殼破損。

Please install switch on flat surface. If it is installed in uneven surface, switch deflection, malfunction and cover breakage will happen.

■ 關於微小負載電路中的使用 Concerning use in small load circuit

如果在開關微小負載電路中使用一般負載用開關，可能會引起接觸不良。

Use general load switch in small load circuit, bad contact maybe happen.

請參考下圖在使用區域的範圍內使用開關，並根據需要插入觸點保護電路。

Please refer to the chart below, use switch within using region, and insert contact to protect circuit according to the needs.

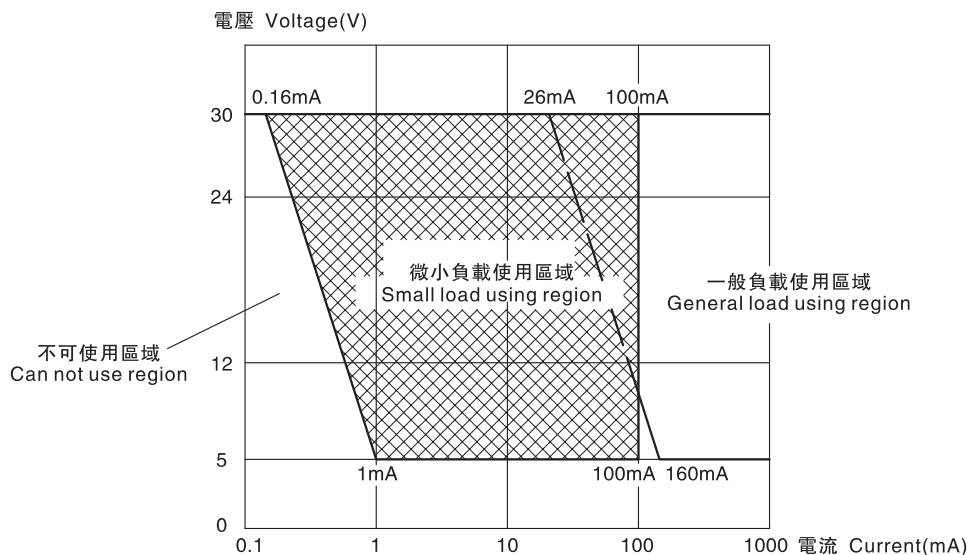

微動開關系列
MICRO SWITCH SERIES

- KW3A
- KW4A**
- KW4A(S)
- KW10
- MS1
- MS2
- MS3
- MS5
- MS10

防水開關系列
WATERPROOF SWITCH SERIES

- WS1
- WS1L
- WS2
- WS3
- WS4
- WS5
- WS6
- WS7

電源開關系列
POWER SWITCH SERIES

- KDC-A11
- KDC-A04
- PS4
- PS5
- PS6
- RS1
- RS2
- RS3

其他開關系列
OTHER SWITCH SERIES

- SP02
- KXZ2
- PRS1